

## Proportional Control Solenoids for Hydraulics

# 3

Product group

## G RF 035 ... B02

Pamphlet

- To VDE 0580
- Armature space pressure-tight up to 3 bar, test medium air, also suitable for dry operation
- Magnetic-force vs stroke graph in the operating range horizontal to slightly decreasing
- To a great extent proportional relation between force and current
- Very small hysteresis through precise special bearing of the armature
- Short operating times
- Push type design
- Coil winding to insulation rating F
- Electrical connection and protection rating if mounted properly:
  - Spade connectors to DIN 46247  
Protection rating to DIN VDE 0470/EN 60529 – IP 00
  - Plug connector type Z KB G to DIN 43650  
cable gland (4 x 90°)  
Protection rating to DIN VDE 0470/EN 60529 – IP 65
- Mounting with 4 screws
- Sealing between solenoid and valve through O-ring
- Modifications and special designs as well as accessories such as LVDT's and control circuit on request
- Application examples:  
Particularly used as proportional actuator in pneumatic and hydraulic control chains and control circuits.

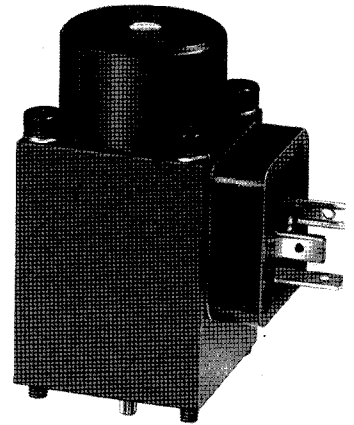

Fig. 1: Type G RF Y 035 F20 B02

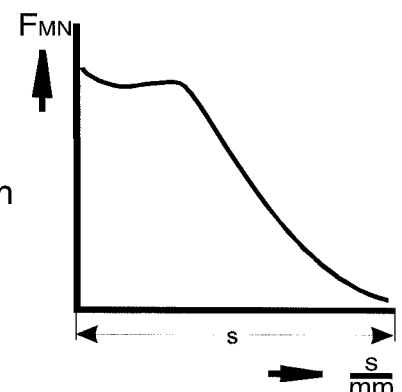

Fig. 2: Magnetic force vs stroke graph



## Technical data

<b>G RF Y 035 F20 B02</b>		
Operating mode		S1
Reference Temperature $\vartheta_{11}$	(°C)	50/
Stroke s	(mm)	2,1 <sup>+ 0,54</sup> <sub>- 0,14</sub> <sup>1)</sup>
Rated magnetic force $F_{MN}$	(N)	58
Rated force hysteresis $H_{FN}$	(%)	~ 2,5
Rated current hysteresis $H_{IN}$	(%)	< 3,5
Rated linearity deviation $L_N$	(%)	2
Armature weight $m_A$	(kg)	0,03
Solenoid weight $m_M$	(kg)	0,43
Rated resistance $R_{20}$	(Ω)	24,6
Rated current $I_N$	(A)	0,68
Maximum current $I_G$	(A)	0,68
Linearity current $I_L$	(A)	0,123
Response current $I_A$	(A)	0,043
Rated power $P_{ON} = I_N^2 \cdot R_{20}$	(W)	11,4
Maximum power $P_G = I_G^2 \cdot R_{20}$	(W)	17,4
Linearity power $P_L = I_L^2 \cdot R_{20}$	(W)	0,37
Response power $P_A = I_A^2 \cdot R_{20}$	(W)	0,046

Rated voltage  $\bar{U} = 24$  V. For power supply via an electronic gain control amplifier, the rated voltage has to be adjusted correspondingly.

The indicated technical data refer to an A.C. power supply with bridge rectifier. The coil winding can be adjusted to other current and resistance values on request.

Owing to natural dispersion magnetic-force values may deviate by  $\pm 5\%$  from the listed values.

Maximum power is based on mounting on a valve block with the minimum dimensions 46 x 46 x 66 mm with a base plate 46 x 66 x 30 mm.

Interior of the solenoid and armature bearing are resistant to all neutral fluids that are commonly used in pneumatics. Please contact us if you use other operating media.

Please find further details and definitions in our **Technical Bulletin** or in **VDE 0580**.

**Note on the technical harmonisation guidelines within the EU**



Electromagnetic solenoids of this product range are subject to the low-voltage guideline 73 / 23 EWG.

To guarantee the targets of this regulation, products are manufactured and inspected to the valid edition of DIN VDE 0580. This also equals a declaration of conformity by the manufacturer.

**Note on the EMC (electromagnetic compatibility) guideline 89/336 EWG**

Electromagnetic solenoids are not affected by this guideline because neither do they cause electromagnetic disturbances, nor can they be disturbed through electromagnetic disturbances. Therefore, the adherence to the EMC guideline has to be guaranteed by the user through appropriate circuitry wiring. Examples for protection circuits can be taken from the corresponding technical documents.

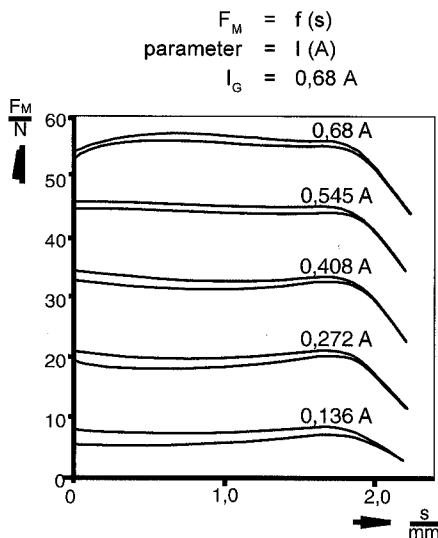

Fig. 2: Magnetic force vs stroke graph

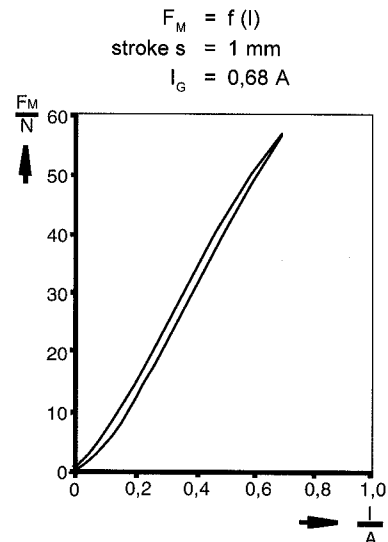
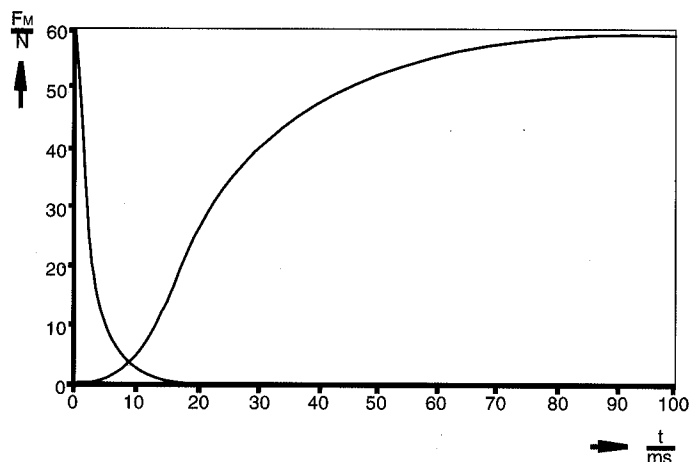

Fig. 3: Magnetic force vs current graph at constant stroke

## Dimensions sheet



The solenoid shown is not a ready-to-use device in the sense of DIN VDE 0580. The general requirements and protective measures to be taken by the user are included in DIN VDE 0580.

Fig. 5: Increase and decrease in the magnetic force depending on time

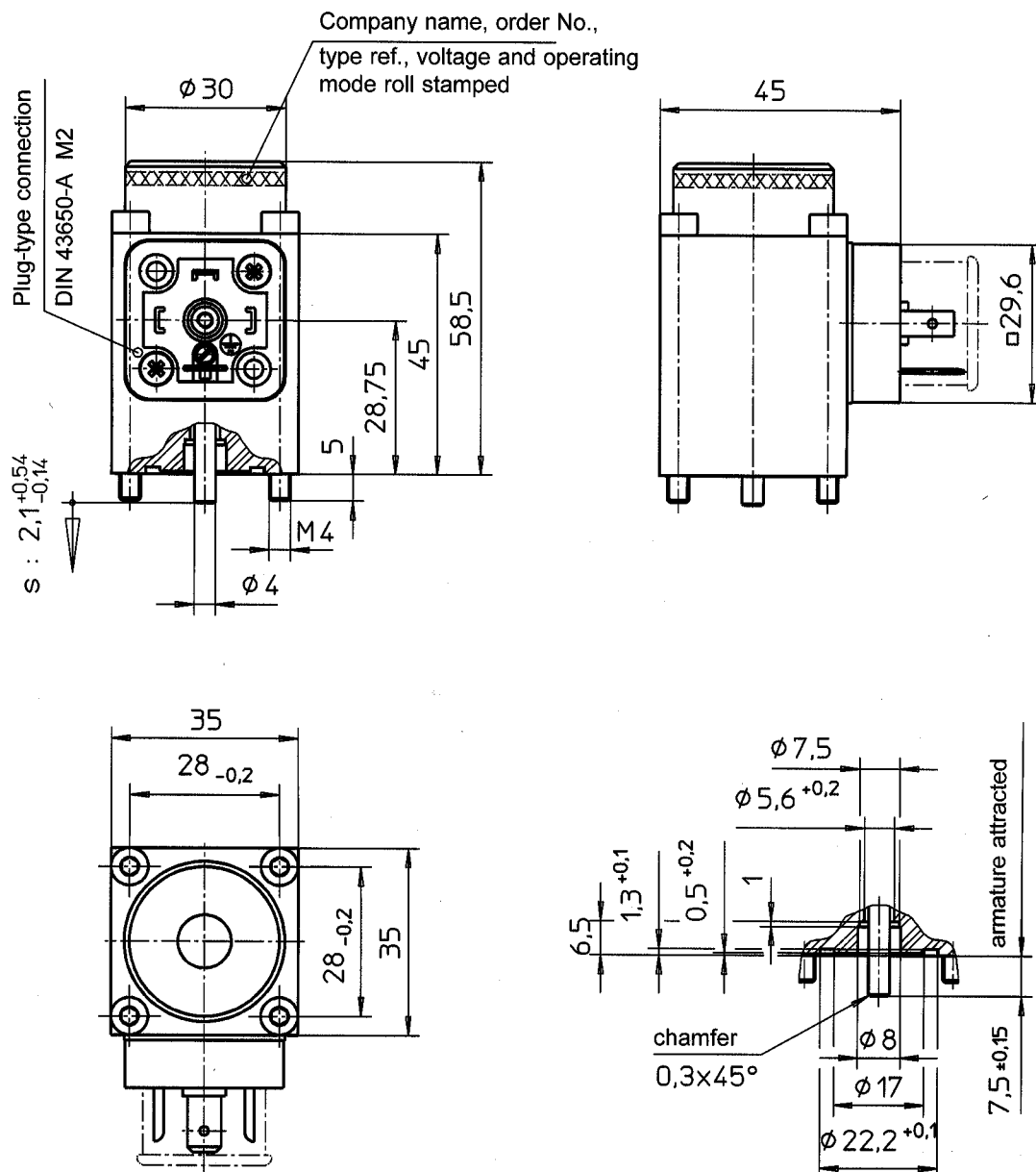

Fig. 6: Type G RF Y 035 F20 B02



### Type code

	<b>G</b>	<b>RF</b>	<b>Y</b>	<b>035</b>	<b>F</b>	<b>20</b>	<b>B02</b>
Equipment group							
Basic construction							
Modifications							
Size							
Arrangement							
Basic protection							
Design number							

### Order Example

Type	G RF Y 035 F20 B02
Voltage	== 24 V DC
Operating mode	S1

### Specials

Special designs and modifications are available on request for which full application conditions should be specified in accordance with our -Technical Bulletins.

Special designs such as adjustable pushrod, optional deaeration of the armature space, flame-proof design, integrated inductive transducer, available on request.