

## Proportional Solenoid for Hydraulic Application with Inductive Transducer

# 4

Product group

## G RF ... B61, B62

### Proportional Solenoid

- To VDE 0580
- Armature space pressure-proof up to MSM W0120-01, test pressure static 350 bar, also suitable for dry operation
- Force approximately proportional to current
- Minimum hysteresis due to special precision armature bearings
- Short actuating times
- Coil winding according to insulation rating F
- Electrical connection and protection rating if mounted properly:
  - Spade connectors to DIN 46247  
Protection to DIN VDE 0470/EN 60 529 - IP 00
  - Plug connector Z KB to DIN 43650  
Cable gland (4 x 90° positions)  
Protection to DIN VDE 0470/EN 60529 - IP 65

### Inductive Transducer

- Integrated demodulation stage with carrier frequency oscillator and calibrated output sensitivity
- Two designs with 20 Hz and 500 Hz limiting frequency
- Suitable for dry and pressure-proof applications
- Pressure-proof tube for 350 bar static pressure
- Mounting by square flange
- Electrical connection and protection rating if mounted properly:
  - Connection with plug connector to Messrs. Binder M12x1 series 713
  - Protection to DIN VDE 0470/EN 60329 - IP 65 with sealed read-out potentiometer

### Application examples

Particularly used as proportional actuator in hydraulic control chains and control circuits.



Fig. 1: G RF Y 035 F20 B61



## Technical data

G R F Y 035, 045, 060	F20	B61	B62
Linear stroke	(mm)	± 4	
Supply voltage	(= V)	24 ± 10 %	
Input current	(mA)	< 50	
Sensitivity	(= V / mm)	0,5 ± 1 %	
Output voltage	(= V)	5,5 ... 9,5	
Linearity tolerance	(%)	± 1	
Top limiting frequency (-3 dB)	(Hz)	typ. 20	typ. 500
Reference temper. range	(°C)	0 ... + 50	
Temperature drift	(% / °C)	typ. 0,05	
Load resistance	(kΩ)	> 5	

Technical data for proportional solenoids see pamphlet G R F ... B01.

The rated Voltage of the proportional solenoids is = 24 V DC. If power is e. g. supplied via an electronic automatic volume control amplifier, the rated voltage has to be adjusted accordingly.

### Sensitivity

Sensitivity is the change in the output signal ( $\Delta U$ ) with reference to the change in the measuring path ( $\Delta s$  indicated in V/mm).

$$\text{Sensitivity} = \frac{\Delta U}{\Delta s}$$

### Linearity error

The linearity error indicates the deviation of the output signal from the ideal graph in per cent.

$$\text{deviation}_{\text{Lin}} = \frac{(U_{\text{actual}} - U_{\text{nominal}})}{U_{\text{voltage stroke}}} \times 100 \%$$

### Temperature drift

Temperature drift indicates in per cent the deviation of the output signal per degree of temperature change (shown in % / °C).

$$\text{deviation}_{\text{temp.}} = \frac{(U_{\text{temp}} - U_{20^\circ\text{C}})}{U_{\text{voltage stroke}} \times \Delta T} \times 100 \%$$

Please make sure that the described devices are suitable for your application. Please find further details and definitions in our Technical Explanation or, respectively, in VDE 0580.

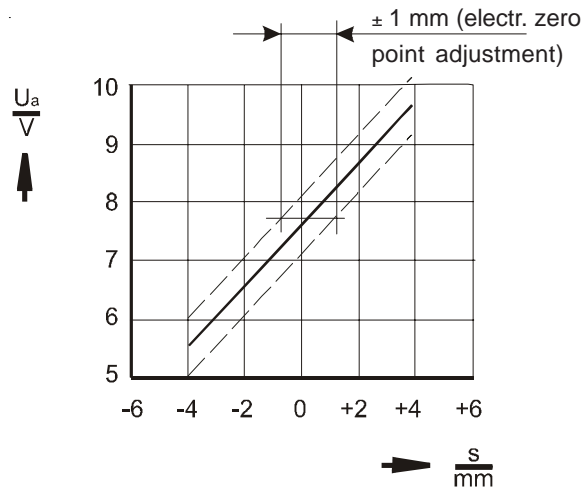

Fig. 2: Voltage vs stroke diagram for transducer with integrated electronic

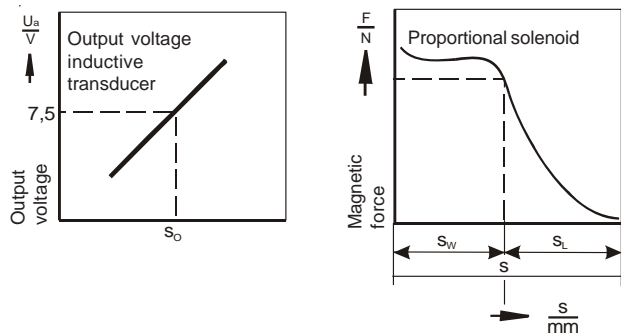

Fig. 3: Output voltage  $U_A$  depending on  $S, S_A, S_0$

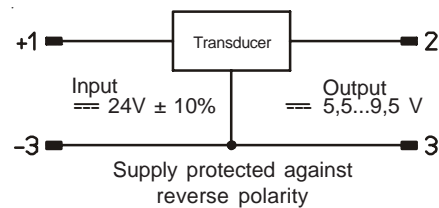

Fig. 4: Block diagram  
Built-in electronics protected against wrong configuration at 1 + 3

### Note on the technical harmonisation guidelines within the EU



Electromagnetic solenoids of this product range are subject to the low-voltage guideline 73 / 23 EWG. To guarantee the targets of this regulation, products are manufactured and inspected to the valid edition of DIN VDE 0580. This also equals a declaration of conformity by the manufacturer.

## Dimensions sheet

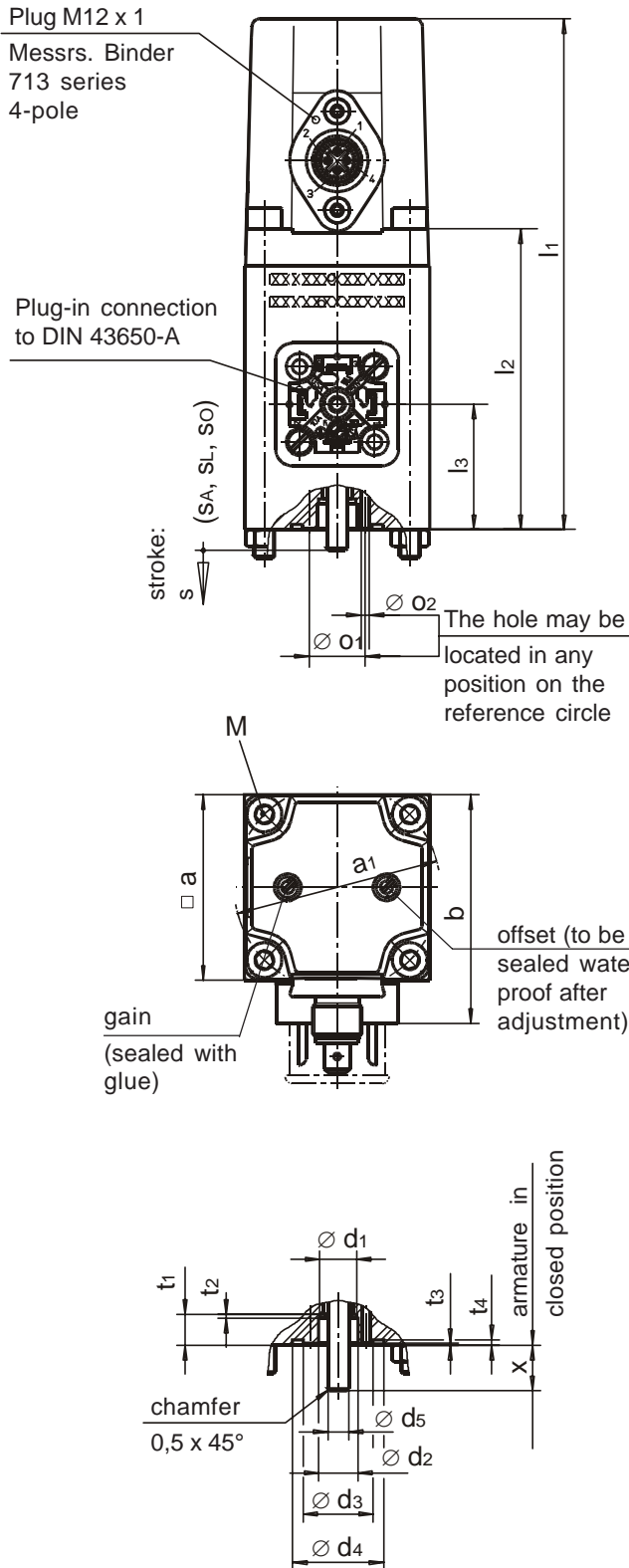

G RF Y ... F20 B61, B62			
Dimensions in mm	035	045	060
□ a	35	45	60
□ a1	28	35,35	48,1
b	45	55	70
l1	117	124	142
l2	66	73	91
l3	28,75	30,25	41,2
M	M4	M5	M6
∅ o1	1,8	2	3
∅ o2	1,2	13,6	189
t1	6,5	7,5	10
t2	1	1	2
t3	0,5 <sup>+0,2</sup>	0,5 <sup>+0,2</sup>	0,5 <sup>+0,2</sup>
t4	1,3 <sup>+0,1</sup>	1,3 <sup>+0,1</sup>	1,3 <sup>+0,1</sup>
x	7,5 <sup>+0,15</sup>	11 <sup>+0,2</sup>	12 <sup>+0,2</sup>
∅ d1	7,5	9	12
∅ d2	8	9,5	12,5
∅ d3	17	17	23,3
∅ d4	22,2 <sup>+0,2</sup>	22,2 <sup>+0,2</sup>	29,7 <sup>+0,2</sup>
∅ d5	4	5	6
S (overall stroke)	4 <sup>+0,3</sup>	6 <sup>+0,3</sup>	8 <sup>+0,4</sup>
S <sub>W</sub> (working stroke)	2	3	4
S <sub>L</sub> (idle stroke)	2	3	4
S <sub>O</sub> transducer O-position (=7,5 V) at stroke sA	2	3	4

**Fig. 5:** Types G RF Y 035 F20 B61, B62  
G RF Y 045 F20 B61, B62  
G RF Y 060 F20 B61, B62

The solenoids shown are not ready-to-use devices in the sense of DIN VDE 0580. The general requirements and protective measures to be taken by the user, are included in DIN VDE 0580. The use of the shown devices in safety relevant applications need always the written agreement of MSM.



## Type code

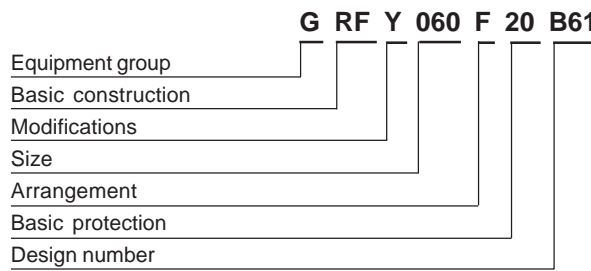

## Order Example

Type                    G RF Y 060 F20 B61  
Voltage                 24 V DC  
Operating mode        S1 (100 %)

## Specials

Please do not hesitate to ask us for application-oriented problem solutions. In order to find rapidly a reliable solution we need complete details about your application conditions. The details should be specified as precisely as possible in accordance with the relevant  - technical explanations.

If necessary, please request the support of our corresponding technical office.