

## Proportional Solenoids for Hydraulics

# 4

Product group

## G RF ... B01

- According to VDE 0580
- Armature space pressure-tight up to 350 bar
- Also suitable for dry operation
- Magnetic-force vs stroke graph in the operating range horizontal to slightly decreasing
- To a great extent proportional relation between force and current
- Very small hysteresis through precise special bearing of the armature
- Short operating times
- Push type design
- Coil winding to insulation rating F
- Electrical connection and protection rating if mounted properly:
  - Spade connectors to DIN 46247  
Protection rating to DIN VDE 0470/EN 60529 – IP 00
  - Plug connector type Z KB G to DIN 43650  
cable gland (4 positions x 90°)  
Protection rating to DIN VDE 0470/EN 60529 – IP 54
- Mounting with 4 screws
- Sealing between solenoid and valve through O-ring
- Special designs on request
- Application examples:  
Particularly used as proportional actuator in pneumatic and hydraulic control chains and control circuits



Fig. 1: Type G RF Y 035 F20 B01

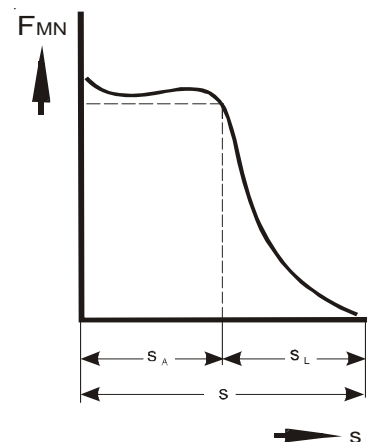

Fig. 2: Magnetic force vs stroke graph



## Technical data

<b>G R F Y ... F20 B01</b>		<b>035</b>	<b>045</b>	<b>060</b>	
Duty rating ED		S1 (100 %)	S1 (100 %)	S1 (100 %)	
Reference temperature $\vartheta_{11}$	(°C)	50	50	50	
Overall stroke s	(mm)	4 ±0,3	6 ±0,3	8 ±0,4	
Working stroke $s_w$	(mm)	2	3	4	
The indicated working stroke $s_w$ is an approximate value. Owing to tolerances that occur, we recommend a stable operating range between	(mm)	0,5 - 1,5	0,5 - 2,5	0,5 - 3,5	
Idle stroke $s_L$	(mm)	2	3	4	
Rated magnetic force $F_{MN}$	(N)	50	65	145	
Rated magnetic force $H_{FN}$ static	(%)	≈ 1,2	≈ 1,7	≈ 1,9	
Rated magnetic force $H_{FN}$ dynamic	(%)	≈ 2	≈ 3	≈ 3,5	
Measured with measuring speed	(mm/min)	20	30	40	
Rated current hysteresis $H_{IN}$	(%)	< 2,5	< 2,5	< 4	
Rated linearity deviation $L_N$	(%)	2	2	2	
Armature weight $m_A$	(kg)	0,03	0,06	0,14	
Solenoid weight $m_M$	(kg)	0,43	0,75	1,75	
Rated resistance $R_{20}$	(Ω)	24,6	21	16,7	
Rated current $I_N$	(A)	0,68	0,81	1,11	
Maximum current $I_G$	(A)	0,68	0,81	1,11	
Linearity current $I_L$	(A)	0,14	0,15	0,15	
Response current $I_A$	(A)	0,05	0,02	0,05	
Rated power $P_N = I_N^2 \cdot R_{20}$	(W)	11,4	13,8	21	
Maximum power $P_G = I_G^2 \cdot R_W$	(W)	17,4	20,8	31	
The maximum power requires mounting on a hydraulic valve base plate with the following minimum dimensions.	hydraulic valve	(mm)	46 x 46 x 66	46 x 46 x 66	67 x 67 x 82
	base plate	(mm)	66 x 46 x 30	66 x 46 x 30	112 x 115 x 30
Linearity power $P_L = I_L^2 \cdot R_{20}$	(W)	0,48	0,47	0,38	
Response power $P_A = I_A^2 \cdot R_{20}$	(W)	0,06	0,0084	0,042	

Rated voltage = 24 V. For power supply via an electronic gain control amplifier, the rated voltage has to be adjusted correspondingly.

The indicated technical data refer to an A.C. power supply with bridge rectifier. The coil winding can be adjusted to other current and resistance values on request.

Owing to natural dispersion magnetic-force values may deviate by  $\pm 5\%$  from the listed values.

Interior of the solenoid and armature bearing are resistant to all neutral fluids that are commonly used in hydraulics. Please contact us if you use other operating media.

**Please make sure that the described devices are suitable for your application. Please find further details and definitions in our  Technical Explanation or, respectively, in VDE 0580.**

**Note on the technical harmonisation guidelines within the EU**



Electromagnetic solenoids of this product range are subject to the low-voltage guideline 73 / 23 EWG.

To guarantee the targets of this regulation, products are manufactured and inspected to the valid edition of DIN VDE 0580. This also equals a declaration of conformity by the manufacturer.

**Note on the EMC (electromagnetic compatibility) guideline 89/336 EWG**

Electromagnetic solenoids are not affected by this guideline because neither do they cause electromagnetic disturbances, nor can they be disturbed through electromagnetic disturbances. Therefore, the adherence to the EMC guideline has to be guaranteed by the user through appropriate circuitry wiring. Examples for protection circuits can be taken from the corresponding technical documents.

**Note on the RoHS guideline 2002/95/ EC**

The devices presented in this document do not fall into the scope of regulation 2002/95/EC („RoHS“) and do not become part of products which fall into the scope according to our state of information. In case of surfaces zinc coating with yellow chromating and zinc iron with black chromating separate agreements are necessary for application according RoHS.

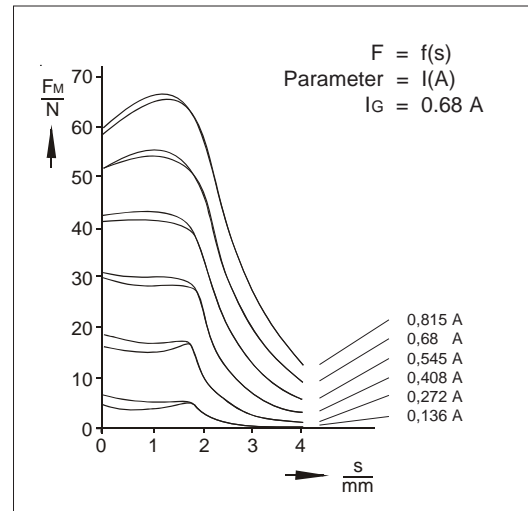

Fig. 3: Magnetic force vs stroke graph Type G RF Y 035 F20 B01

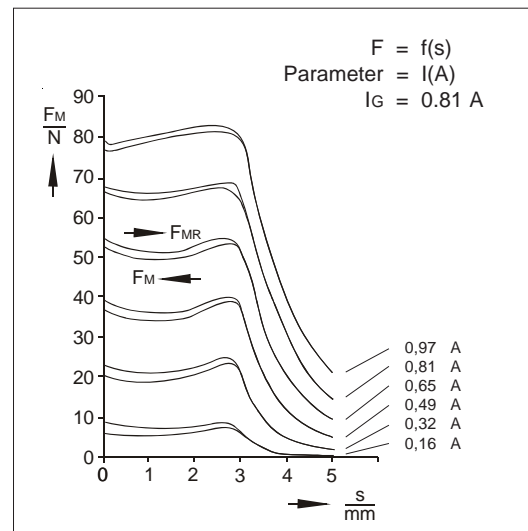

Fig. 3: Magnetic force vs stroke graph Type G RF Y 045 F20 B01

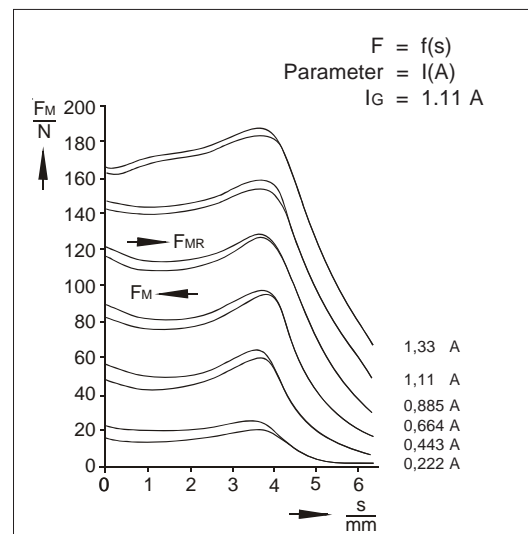
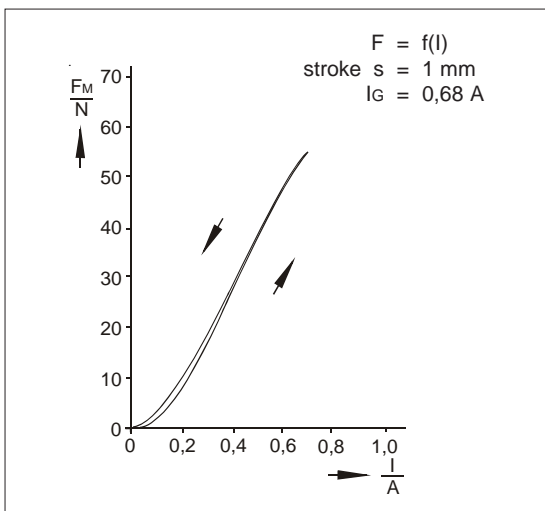
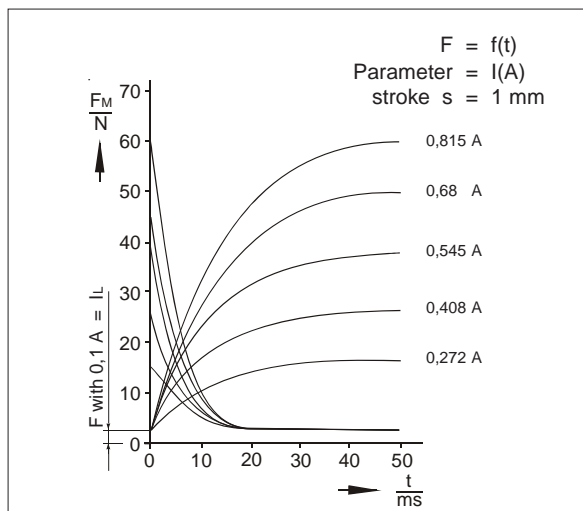

Fig. 4: Magnetic force vs stroke graph Type G RF Y 060 F20 B01



**Bild 4:** Force/current-characteristic with constant stroke  
 Type G RF Y 035 F20 B01



**Bild 5:** Increase and decrease of magnetic force as a function of time  
 Type G RF Y 035 F20 B01

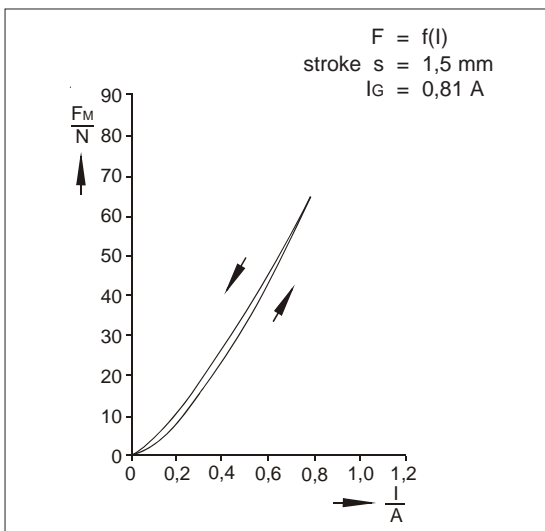

**Bild 7:** Force/current-characteristic with constant stroke  
 Typ G RF Y 045 F20 B01

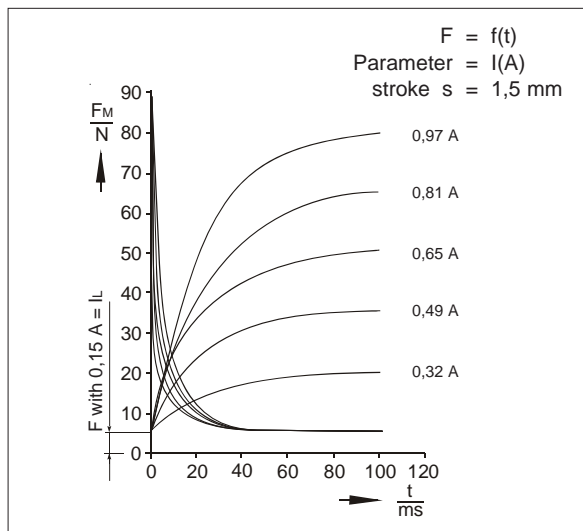

**Bild 8:** Increase and decrease of magnetic force as a function of time  
 Type G RF Y 045 F20 B01

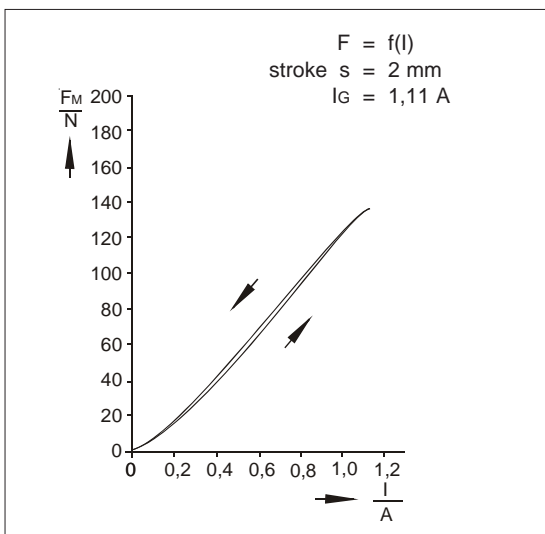

**Bild 10:** Force/current-characteristic with constant stroke  
 Typ G RF Y 060 F20 B01

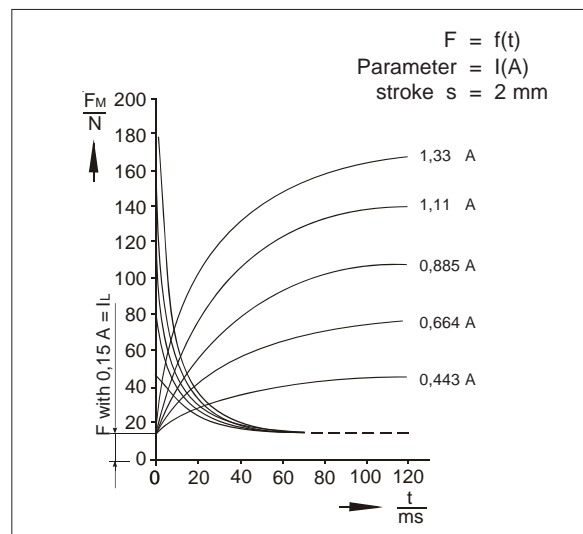

**Bild 11:** Increase and decrease of magnetic force as a function of time  
 Type G RF Y 060 F20 B01

**dimensions**

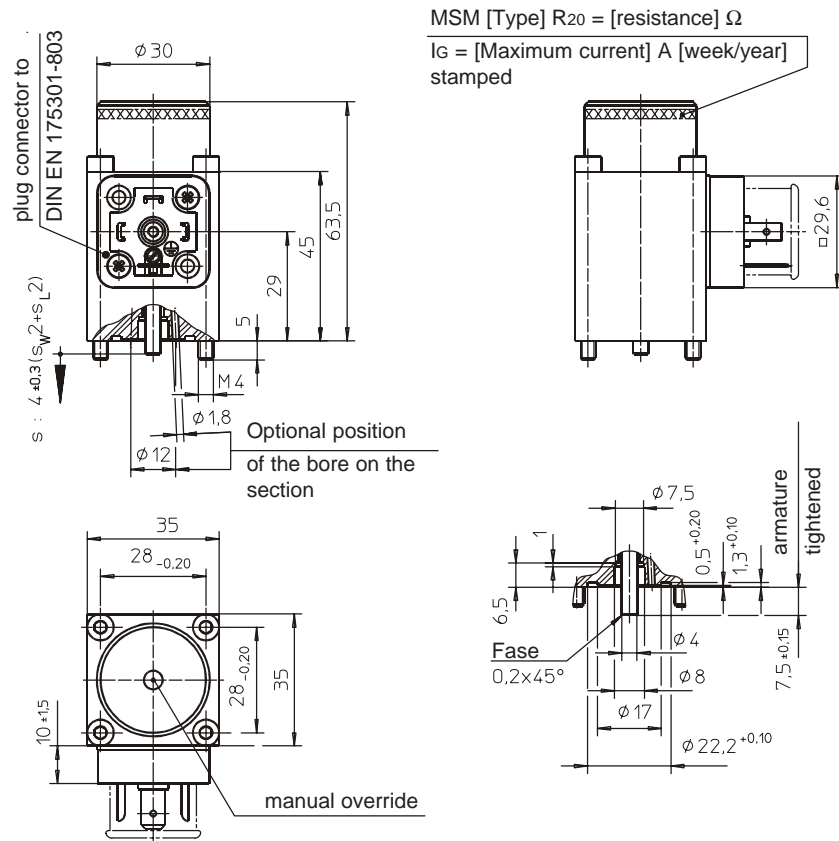

**Fig. 12:** Type G RF Y 035 F20 B01

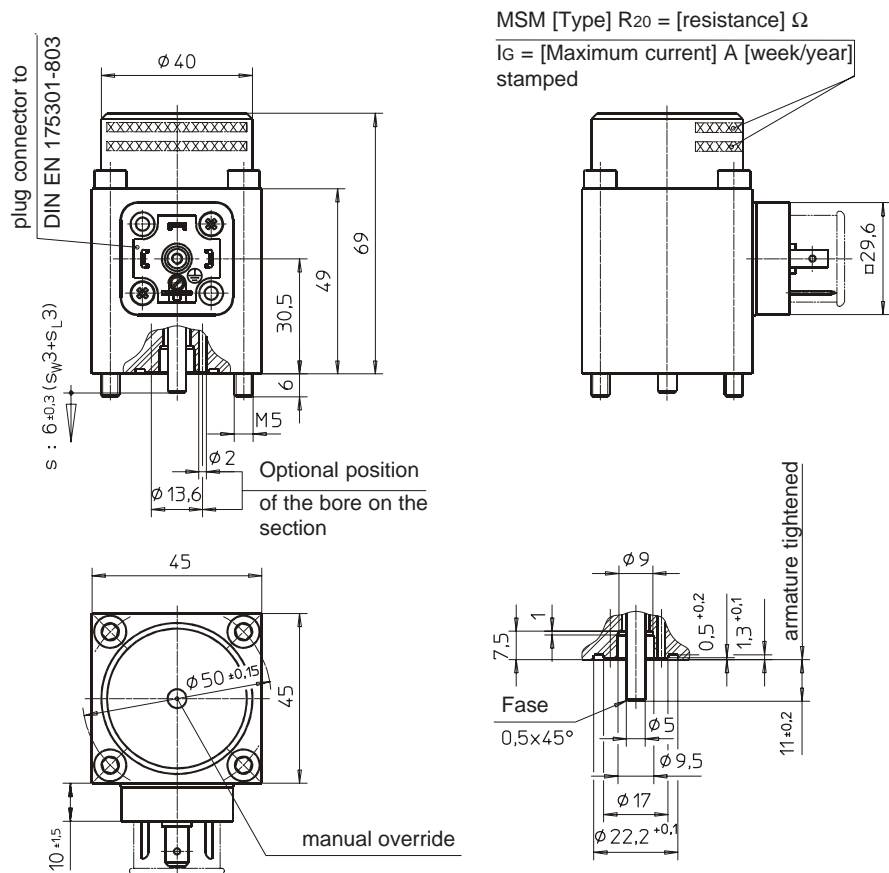

**Fig. 13:** Type G RF Y 045 F20 B01

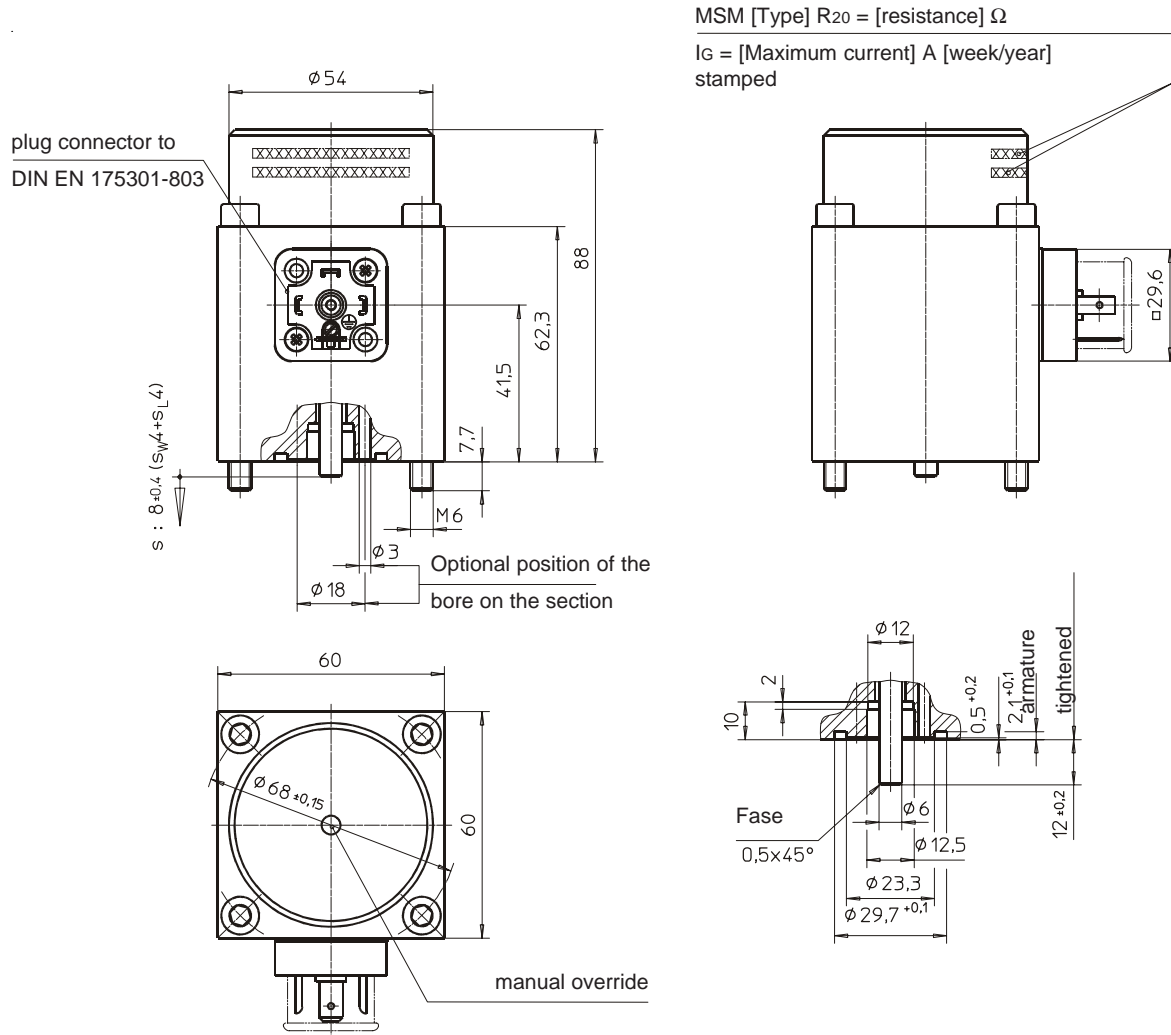
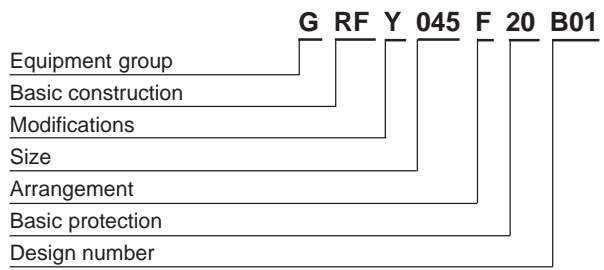

Fig. 14: Type G RF Y 060 F20 B01

The solenoids shown are not ready-to-use devices in the sense of DIN VDE 0580. The general requirements and protective measures to be taken by the user, are included in DIN VDE 0580. The use of the shown devices in safety relevant applications need always the written agreement of MSM.

**Type code**



**Order Example**

Type	G RC Y 037 N54 A01
Voltage	<b>==</b> 24 V DC
Operating mode	S1 (100 %)

**Specials**

Please do not hesitate to ask us for application-oriented problem solutions. In order to find rapidly a reliable solution we need complete details about your application conditions. The details should be specified as precisely as possible in accordance with the relevant - technical explanations. If necessary, please request the support of our corresponding technical office.